

product cost effect: raises product costs and work, or adds parts to the assembly

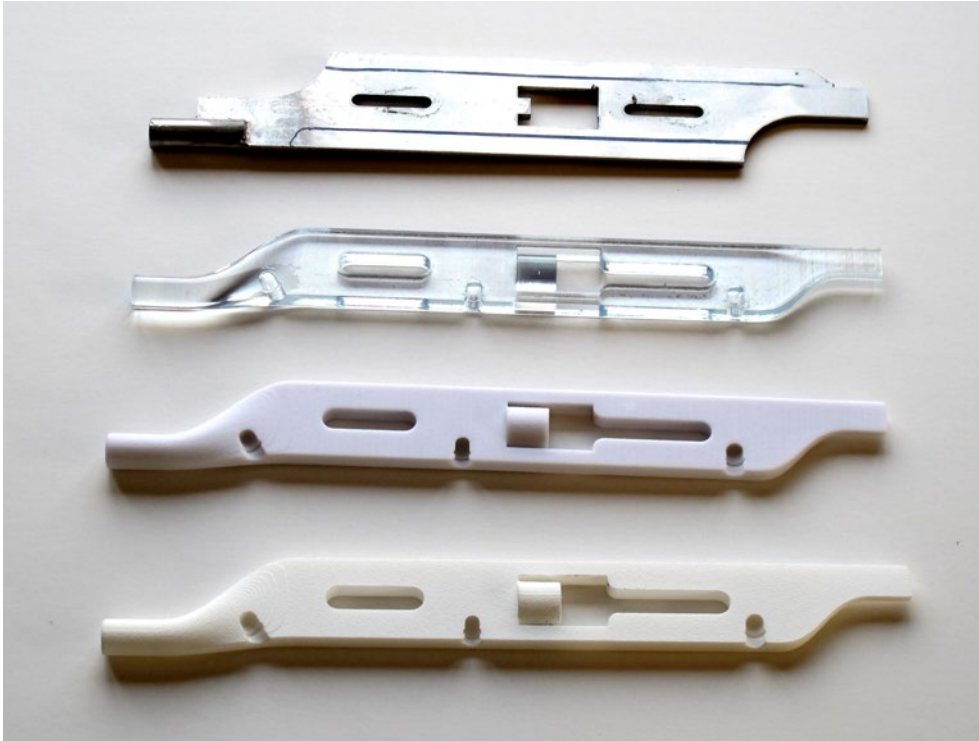

product cost effect: reduces product costs and work, or removes parts from the assembly



**Production series size is from 1 to 10 pcs.**

**It's possible to use different materials and colours with the same 3D model.**

**Better design and better brand image, higher value on the market, better profits.**

**No mold cost.**

# 3D printing as a part of the Jukola7 3D marketing concept:

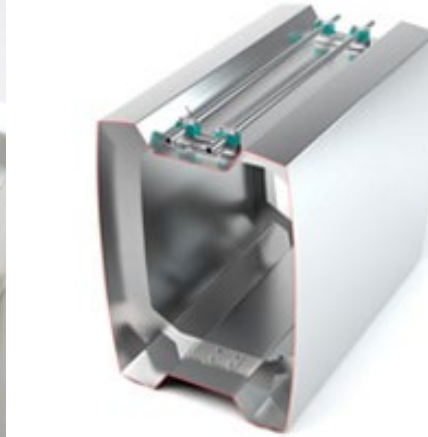

**3D customer trojans**

**360 slider in www**

**Oculus VR marketing demo**

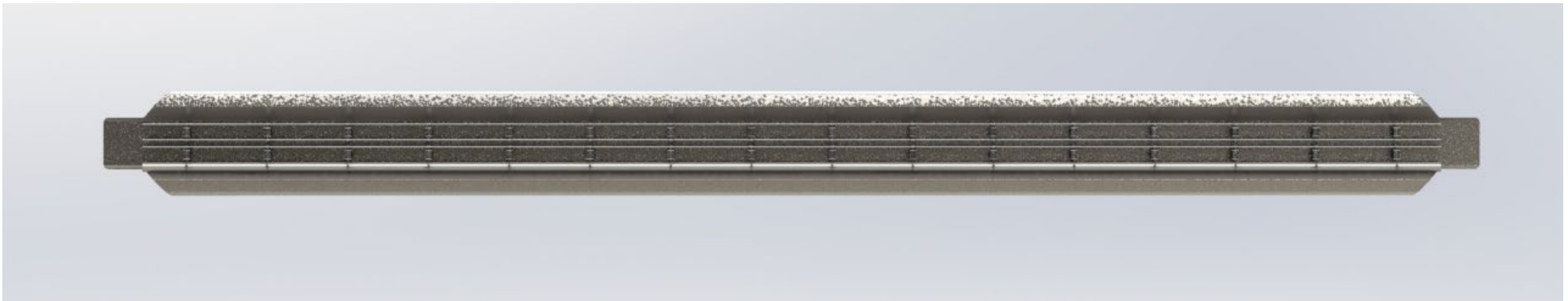

**kilpailija-analyysi  
ja tuote-benchmark**

**luonnostelu / skis-  
saus**

**3D mallinnus**

**FEM analyysi**

**strateginen suunnittelu / tuotelinja analyysi**

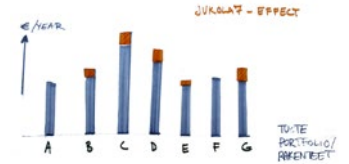
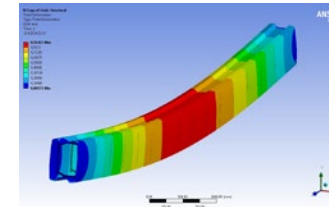
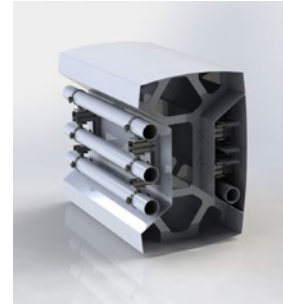
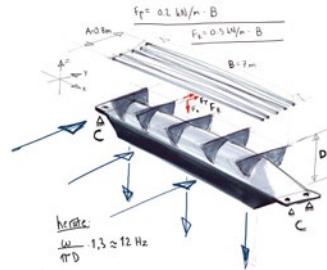

**projektinjohto**

**tuoteanalyysi**

**graafinen suunnittelu**

**tuotekuvat**

**hahmomallit**



## Projektinjohto ja strateginen suunnittelu

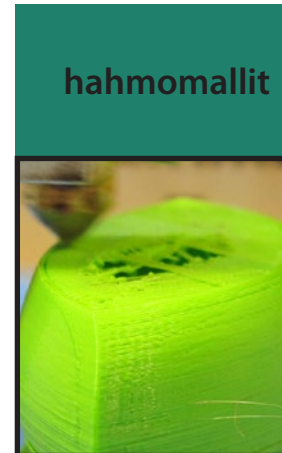
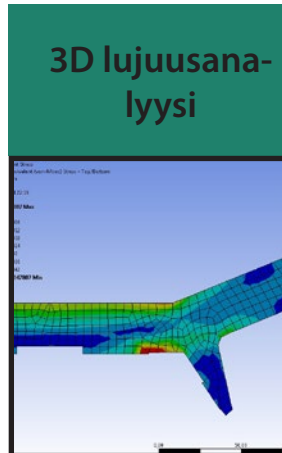
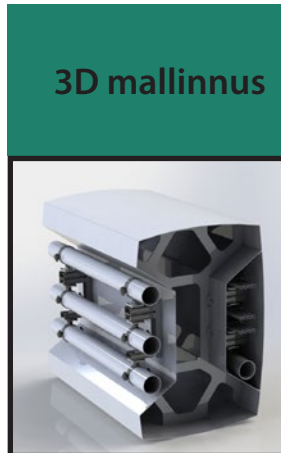
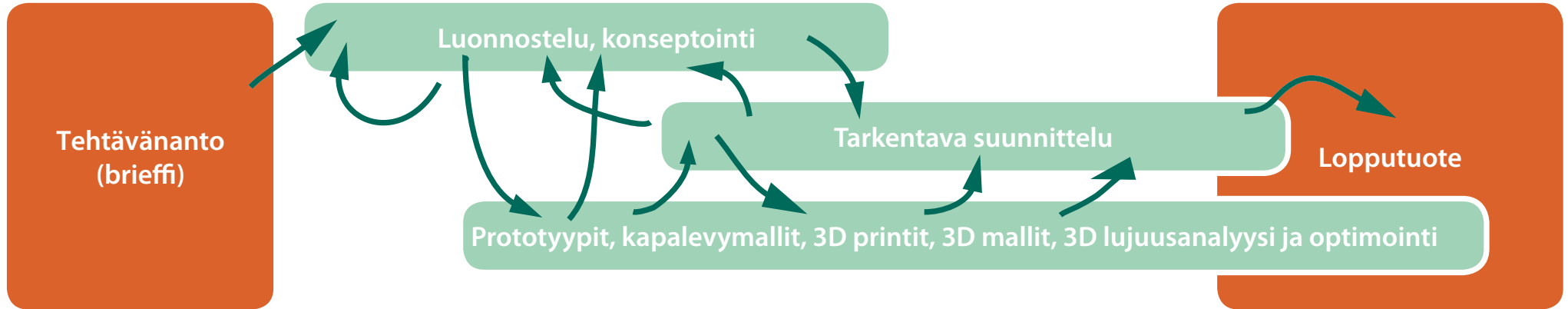

## Jukola7 Standard Structures

**-easy & efficient. Standard solution. Save time, material and money!**

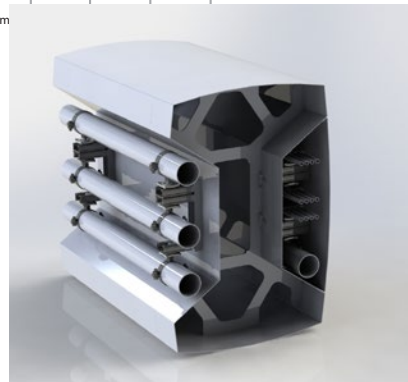
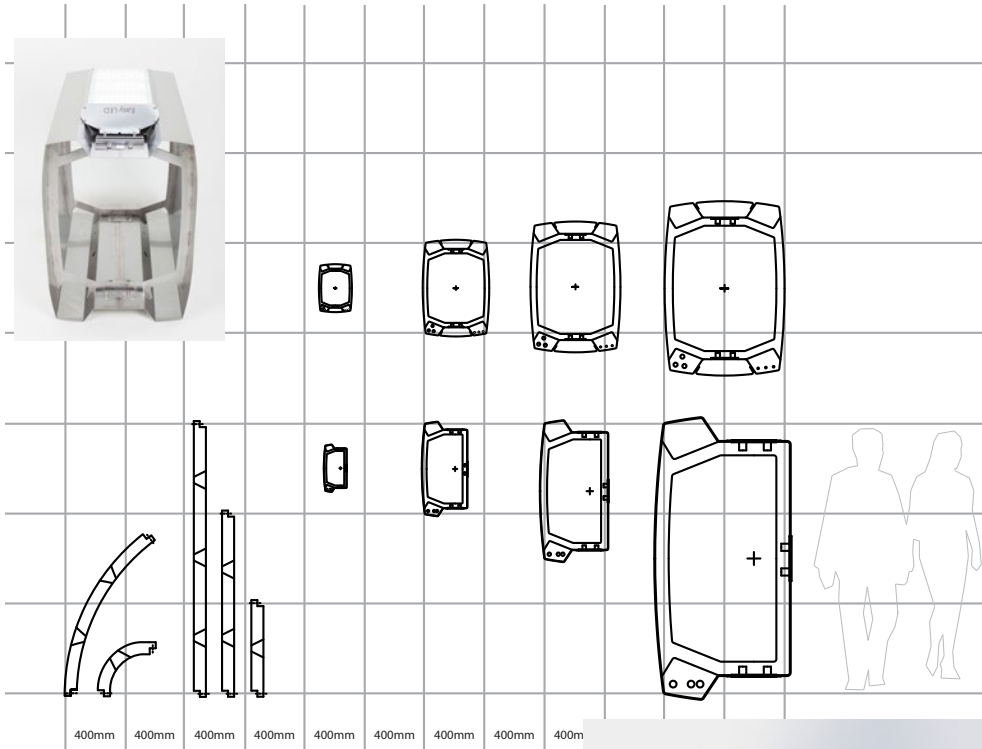

## Jukola7 Structure Service

**- turn-key tailored structures**

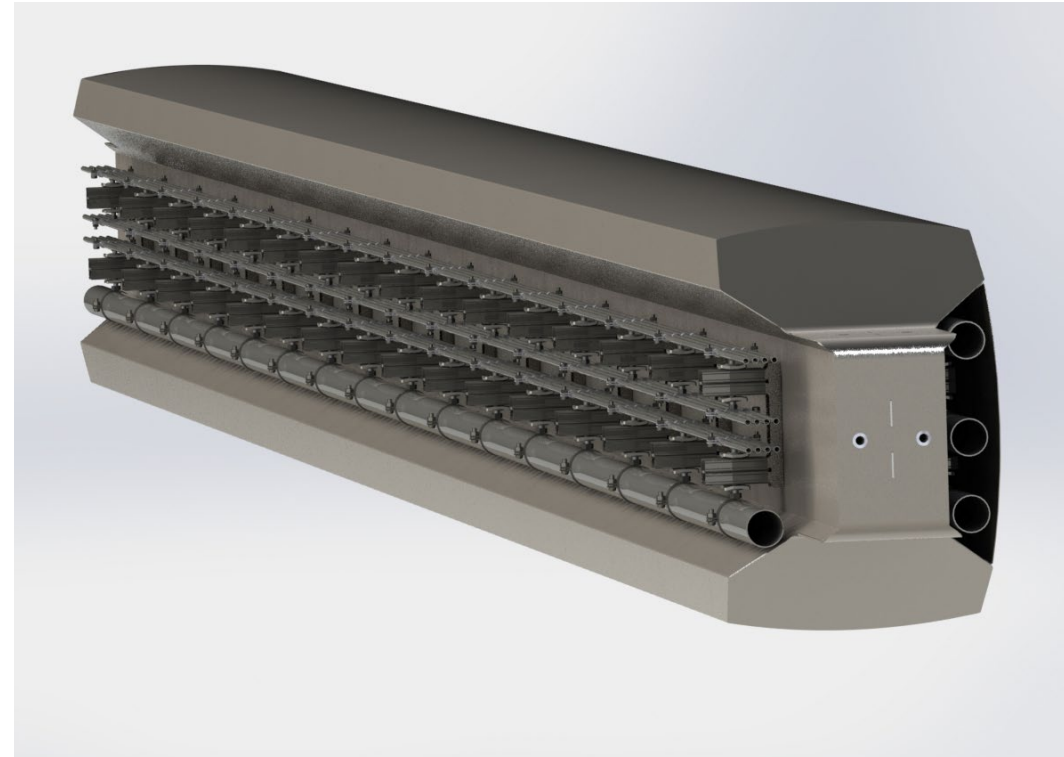

**Call us today, and let's save some material together!**